

Rexroth Inline Terminal With 32 Digital Inputs

R911170554
Edition 01

R-IB IL 24 DI 32/HD-PAC

32 Digital Inputs
24 V DC

02/2007

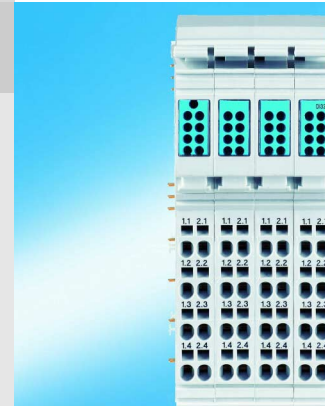

Description

The terminal is designed for use within an Inline station. It is used to acquire digital input signals.

Features

- Connections for 32 digital sensors
- Connection of sensors in single-wire technology
- Diagnostic and status indicators



This data sheet is only valid in association with the application descriptions for the Rexroth Inline system (see "[Documentation](#)" on [page 2](#)).



Make sure you always use the latest documentation. It can be downloaded at www.boschrexroth.com.

Ordering Data

Product

Description	Type	MNR	Pcs./Pck.
Inline terminal with 32 digital inputs; complete with accessories (connectors and labeling fields)	R-IB IL 24 DI 32/HD-PAC	R911170753	1

Documentation

Description	Type	MNR	Pcs./Pck.
"Automation Terminals of the Rexroth Inline Product Range" application description	DOK-CONTRL-ILSYSINS***-AW..-EN-P	R911317021	1
"Configuring and Installing the Rexroth Inline Product Range for INTERBUS" application description	DOK-CONTRL-ILSYSPRO***-AW..-EN-P	R911317023	1



For additional ordering data (accessories), please refer to the product catalog at www.boschrexroth.com.

Technical Data

General Data	
Housing dimensions (width x height x depth)	48.8 mm x 120 mm x 71.5 mm
Weight	185 g (with connectors)
Operating mode	Process data mode with 4 bytes
Transmission speed	500 kbps
Connection method for sensors	Single-wire technology
Ambient temperature (operation)	-25°C to +55°C
Ambient temperature (storage/transport)	-25°C to +85°C
Permissible humidity (operation/storage/transport)	10% to 95% according to DIN EN 61131-2
Permissible air pressure (operation/storage/transport)	70 kPa to 106 kPa (up to 3000 m above sea level)
Degree of protection	IP20 according to IEC 60529
Protection class	Class 3 according to VDE 0106, IEC 60536
Connection data for Inline connector	
Connection method	Spring-cage terminals
Conductor cross section	0.2 mm ² to 1.5 mm ² (solid or stranded), 24 - 16 AWG
Interface	
Local bus	Through data routing
Power Consumption	
Communications power	7.5 V DC
Current consumption at U _L	90 mA, maximum
Power consumption at U _L	0.675 W, maximum
Supply of the Module Electronics and I/O Through Bus Coupler/Power Terminal	
Connection method	Through potential routing

Digital Inputs

Number	32
Input design	According to EN 61131-2 Type 1
Definition of switching thresholds	
Maximum low-level voltage	$U_{Lmax} < 5 \text{ V}$
Minimum high-level voltage	$U_{Hmin} > 15 \text{ V}$
Common potentials	Segment supply, ground
Nominal input voltage U_{IN}	24 V DC
Permissible range	$-3 \text{ V} < U_{IN} < +30 \text{ V DC}$
Nominal input current for U_{IN}	2.8 mA, typical
Delay time	
t_{on}	2 ms
t_{off}	4 ms
Permissible cable length to the sensor	30 m (to ensure conformance with EMC directive 89/336/EEC)
Use of AC sensors	AC sensors in the voltage range $< U_{IN}$ are limited in application (according to the input design)

Input Characteristic Curve

Input Voltage (V)	Typical Input Current (mA)
$-30 < U_{IN} < 0.7$	0
3	0.46
6	1.87
9	2.66
12	2.70
15	2.73
18	2.76
21	2.78
24	2.81
27	2.83
30	2.86

Power Dissipation**Formula to Calculate the Power Dissipation of the Electronics**

$$P_{TOT} = 0.675 \text{ W} + \sum_{i=1}^n [U_{INi} \times I_{INi}]$$

Where

 P_{TOT} Total power dissipation in the terminal
 i Index n Number of set inputs ($n = 1$ to 32) U_{INi} Input voltage of input i I_{INi} Input current of input i according to the input characteristic curve**Limitation of Simultaneity, Derating**

No limitation of simultaneity, no derating

Safety Equipment

Overload in segment circuit	No
Surge voltage	Protective elements of the power terminal
Polarity reversal	Protective elements of the power terminal

Electrical Isolation/Isolation of the Voltage Areas**CAUTION**

To provide electrical isolation between the logic level and the I/O area, it is necessary to supply the station bus coupler and the digital input terminal described here from separate power supply units. Interconnection of the power supply units in the 24 V area is not permitted. (See also application description.)

Common Potentials

24 V I/O voltage, 24 V segment voltage, and GND have the same potential. FE is a separate potential area.

Separate Potentials in the System Consisting of Bus Coupler/Power Terminal and I/O Terminal**- Test Distance**

5 V supply incoming remote bus/7.5 V supply (bus logic)

5 V supply outgoing remote bus/7.5 V supply (bus logic)

7.5 V supply (bus logic)/24 V supply (I/O)

24 V supply (I/O)/functional earth ground

- Test Voltage

500 V AC, 50 Hz, 1 min.

500 V AC, 50 Hz, 1 min.

500 V AC, 50 Hz, 1 min.

500 V AC, 50 Hz, 1 min.

Error Messages to the Higher-Level Control or Computer System

None

Approvals

For the latest approvals, please visit www.boschrexroth.com.

Local Diagnostic and Status Indicators and Terminal Point Assignment

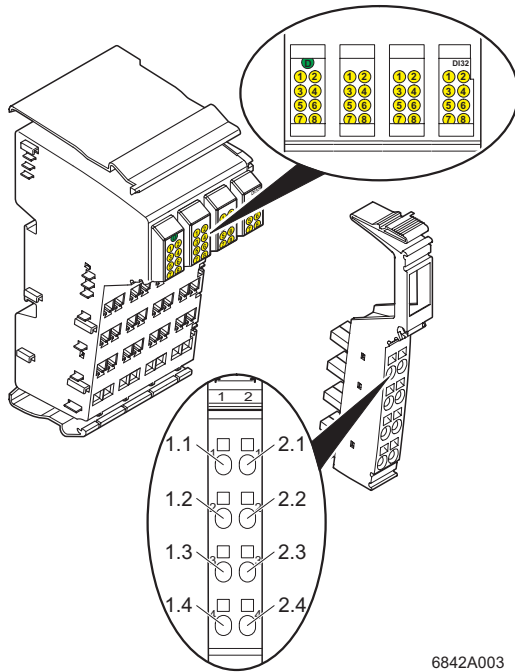

6842A003

Fig. 1 Terminal with one of the appropriate connectors

Local Diagnostic and Status Indicators

Des.	Color	Meaning
D	Green	Diagnostics
For Each Connector		
1 to 8	Yellow	Status indicators of the inputs

Function Identification

Light blue

Terminal Point Assignment for Each Connector

Terminal Point	Assignment
1.1/2.1	Signal input (IN 1/IN 2)
1.2/2.2	Signal input (IN 3/IN 4)
1.3/2.3	Signal input (IN 5/IN 6)
1.4/2.4	Signal input (IN 7/IN 8)
3.1/4.1	Signal input (IN 9/IN 10)
3.2/4.2	Signal input (IN 11/IN 12)
3.3/4.3	Signal input (IN 13/IN 14)
3.4/4.4	Signal input (IN 15/IN 16)
5.1/6.1	Signal input (IN 17/IN 18)
5.2/6.2	Signal input (IN 19/IN 20)
5.3/6.3	Signal input (IN 21/IN 22)
5.4/6.4	Signal input (IN 23/IN 24)
7.1/8.1	Signal input (IN 25/IN 26)
7.2/8.2	Signal input (IN 27/IN 28)
7.3/8.3	Signal input (IN 29/IN 30)
7.4/8.4	Signal input (IN 31/IN 32)



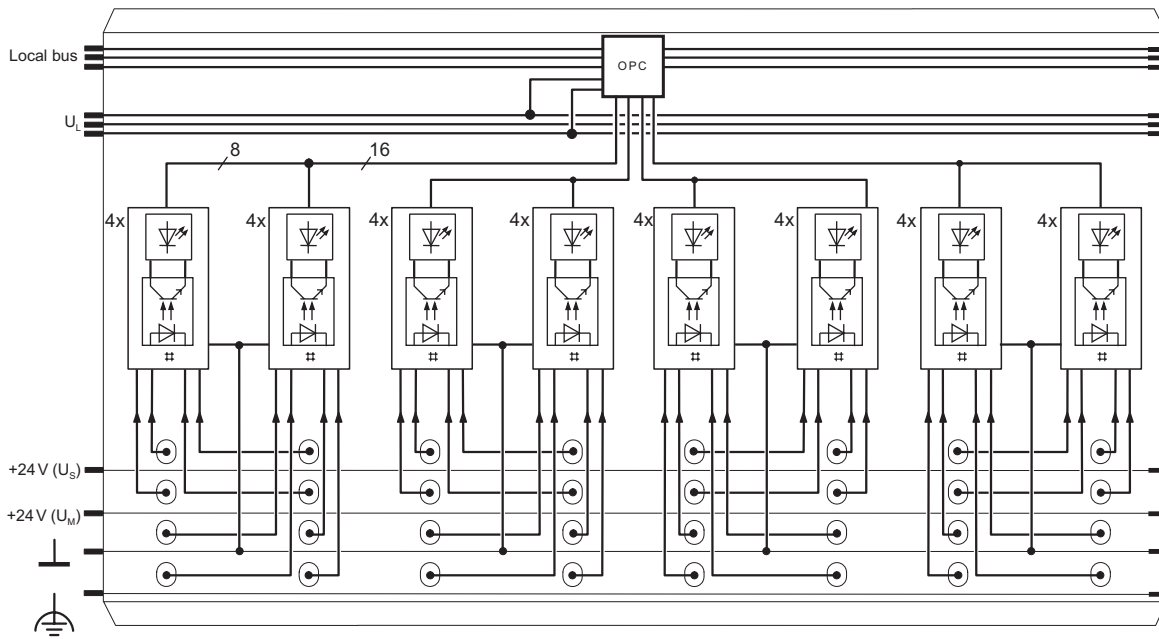

Internal Circuit Diagram



6842A004

Fig. 2 Internal wiring of the terminal points

Key:

-  Protocol chip (bus logic including voltage conditioning)
-  LED (status indicator)
-  Optocoupler
-  Digital input



Other symbols used are explained in the DOK-CONTRL-ILSYSPRO***-AW..-EN-P application description or the application description for your bus system.

Connection Notes and Examples



CAUTION

Please note that the terminal must be provided with supply voltage U_S , as it is used internally as the auxiliary voltage.



CAUTION

When connecting the sensors observe the assignment of the terminal points to the process data (see [page 9](#)).



CAUTION

The sensors and U_S must be supplied from the same voltage supply (see [Fig. 4](#)).



The slot numbering corresponds to the connector labeling of the recommended connector set R-IB IL DI/DO 8-PLSET or the original PAC version.

The sensors can be connected via external busbars. Ensure that the sensors and U_S are supplied from the same voltage supply.

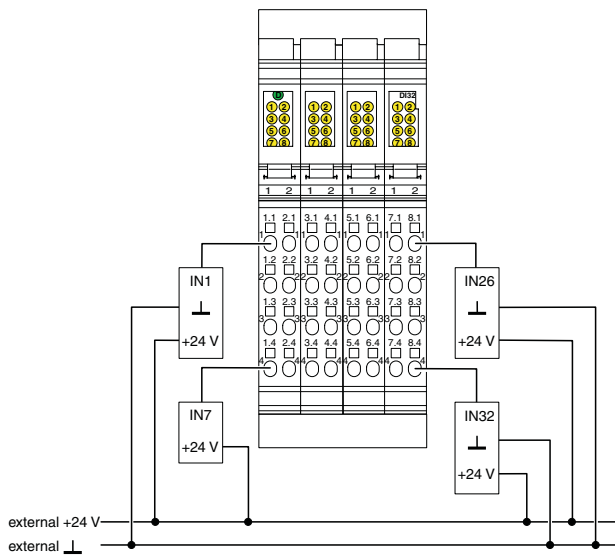

6842A001

Fig. 3 Typical connection of sensors when using external busbars

Application Example

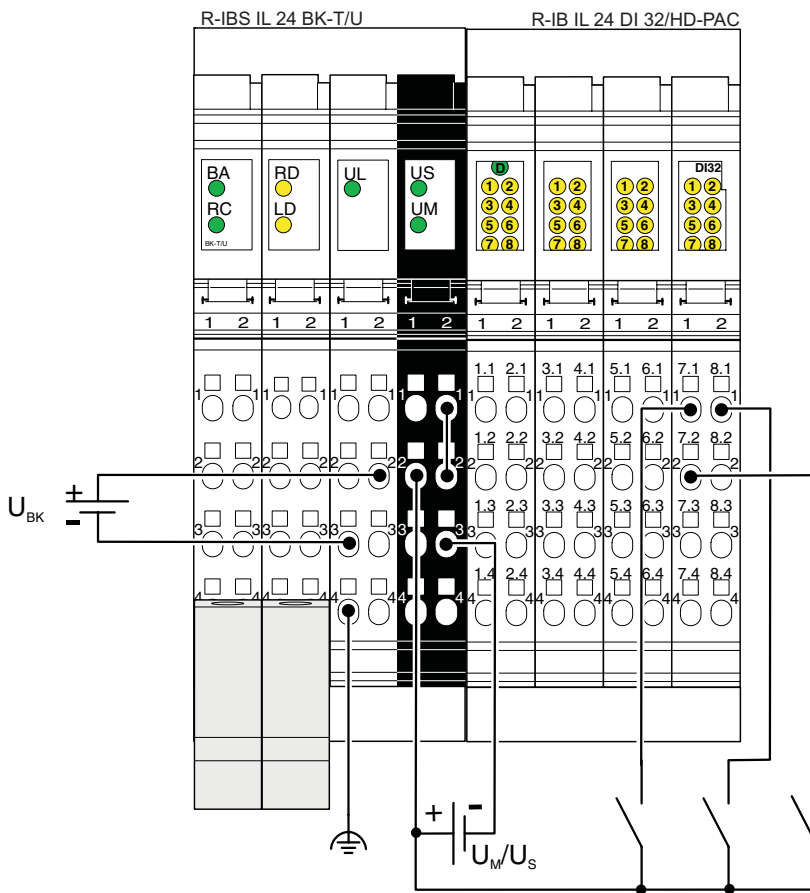

Fig. 4 Connection of sensors when using external busbars

7379A007

Process Data

Assignment of the Terminal Points to the IN Process Data

(Byte.bit) view	Byte	Byte 0								Byte 1							
	Bit	7	6	5	4	3	2	1	0	7	6	5	4	3	2	1	0
Module	Terminal point (signal)	2.4	1.4	2.3	1.3	2.2	1.2	2.1	1.1	4.4	3.4	4.3	3.3	4.2	3.2	4.1	3.1
Status indicator	Slot	1								2							
	LED	8	7	6	5	4	3	2	1	8	7	6	5	4	3	2	1

(Byte.bit) view	Byte	Byte 2								Byte 3							
	Bit	7	6	5	4	3	2	1	0	7	6	5	4	3	2	1	0
Module	Terminal point (signal)	6.4	5.4	6.3	5.3	6.2	5.2	6.1	5.1	8.4	7.4	8.3	7.3	8.2	7.2	8.1	7.1
Status indicator	Slot	3								4							
	LED	8	7	6	5	4	3	2	1	8	7	6	5	4	3	2	1

Programming Data

Local Bus

ID code	BE _{hex} (190 _{dec})
Length code	02 _{hex}
Input address area	4 bytes
Output address area	0 bytes
Parameter channel (PCP)	0 bytes
Register length (bus)	4 bytes

Other Bus Systems



For the programming data of other bus systems, please refer to the corresponding electronic device data sheet (e.g., GSD, EDS).

Notes:

DOK-CONTRL-ILDI32/
HD**-KB01-EN-P

Bosch Rexroth AG
Electric Drives and Controls
P.O.Box 13 57
97803 Lohr, Germany
Bgm.-Dr.-Nebel-Str. 2
97816 Lohr, Germany
Tel. +49-(0) 93 52 - 40-50 60
Fax. +49-(0) 93 52 - 40-49 41
service.svc@boschrexroth.de
www.boschrexroth.com

All rights reserved. No part of this document may be reproduced or stored, processed, duplicated or circulated using electronic systems, in any form or by any means, without the prior written authorization of Bosch Rexroth AG, Electric Drives and Controls. Violations shall give rise to claims for damages. The data specified above only serve to describe the product. They do not indicate any specific condition or suitability for a certain application. The information provided does not release the user from the obligation of own judgement and verification. It must be remembered that our products are subject to natural wear and aging.

Reprint forbidden - subject to modifications